

# PATTERN CATALOG GLASS ORDER FORM

Customer Name \_\_\_\_\_ Date \_\_\_\_\_

Job Name \_\_\_\_\_ P.O. # \_\_\_\_\_

shape **4**

H \_\_\_\_\_ W1 \_\_\_\_\_  
H1 \_\_\_\_\_  
W \_\_\_\_\_

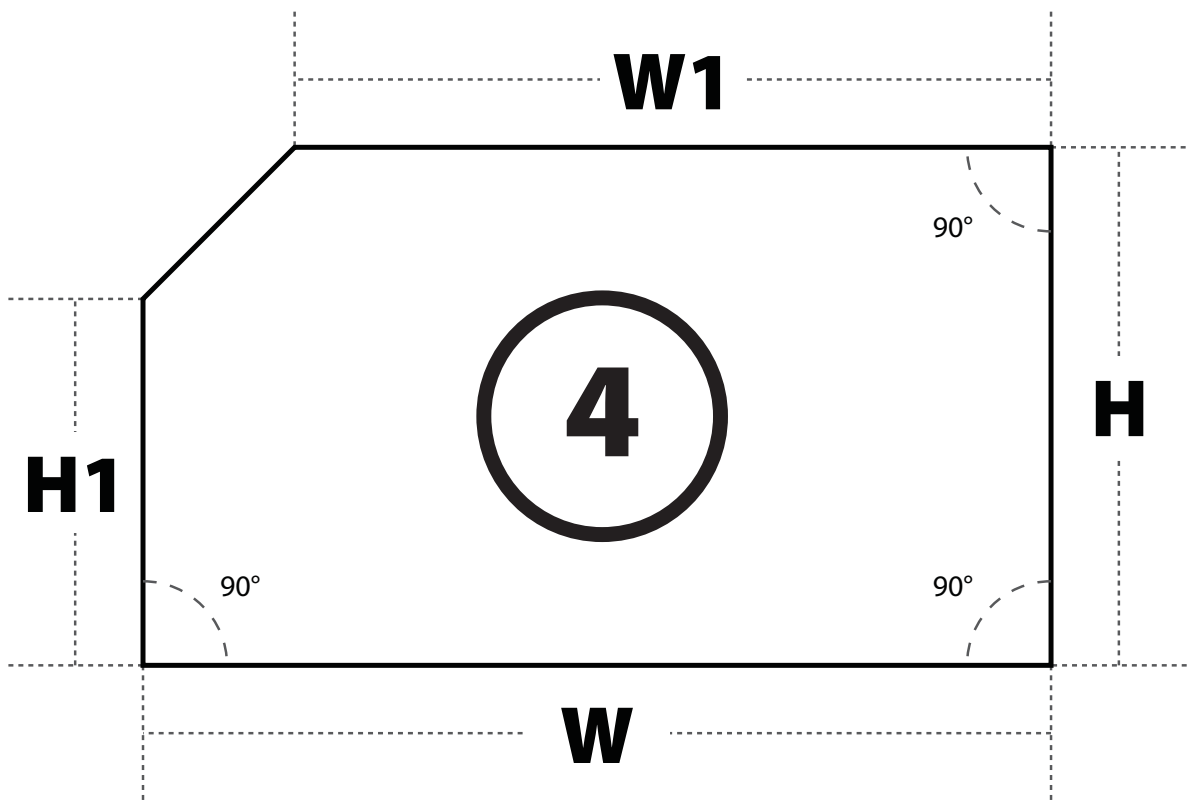

www.craftsmanfab.com

**ALL DRAWINGS ARE VIEWED FROM OUTSIDE OF OPENING**

**MONOLITHIC**

**INSULATED**

**LAMINATED**

Annealed / Tempered / HS \_\_\_\_\_ Annealed / Tempered / HS \_\_\_\_\_ Annealed / Tempered / HS \_\_\_\_\_

Glass Type \_\_\_\_\_ Overall Unit Thickness \_\_\_\_\_ Overall Unit Thickness \_\_\_\_\_

Thickness \_\_\_\_\_ Glass Type \_\_\_\_\_ / \_\_\_\_\_ Glass Type \_\_\_\_\_ / \_\_\_\_\_

Quantity \_\_\_\_\_ Glass Thickness \_\_\_\_\_ / \_\_\_\_\_ Glass Thickness \_\_\_\_\_ / \_\_\_\_\_

Mark # \_\_\_\_\_ Spacer Color / Thickness \_\_\_\_\_ PVB Color \_\_\_\_\_

Edgework \_\_\_\_\_ Edgework \_\_\_\_\_ Thickness \_\_\_\_\_

Logo  Y  N

Logo  Y  N

Edgework \_\_\_\_\_